



**VERTIV WHITE PAPER**

# Strengthening Mission-Critical Microgrids with a Battery Energy Storage System

## Table of Contents

---

|   |    |
|---|----|
| Executive Summary                             | 1  |
| What Is a Microgrid?                          | 3  |
| Microgrid Characteristics                     | 3  |
| What a Microgrid is Not                       | 4  |
| Microgrid Control Systems                     | 4  |
| Maximizing Grid Services                      | 6  |
| Implementing Switchgear                       | 7  |
| Why BESSs Use Li-Ion Batteries                | 7  |
| How Microgrid Applications Benefit Businesses | 8  |
| How to Plan BESS Integrations into Microgrids | 10 |
| A Final Thought on Connecting to Utilities    | 12 |
| Conclusion                                    | 12 |
| References                                    | 14 |

---

## Executive Summary

U.S. customers experienced an average of nearly eight hours of power interruptions in 2021, the second-highest outage level since the U.S. Energy Information Administration began collecting electricity reliability data in 2013. (See Figure 1 below).

# U.S. electricity customers averaged over seven hours of power interruptions in 2021

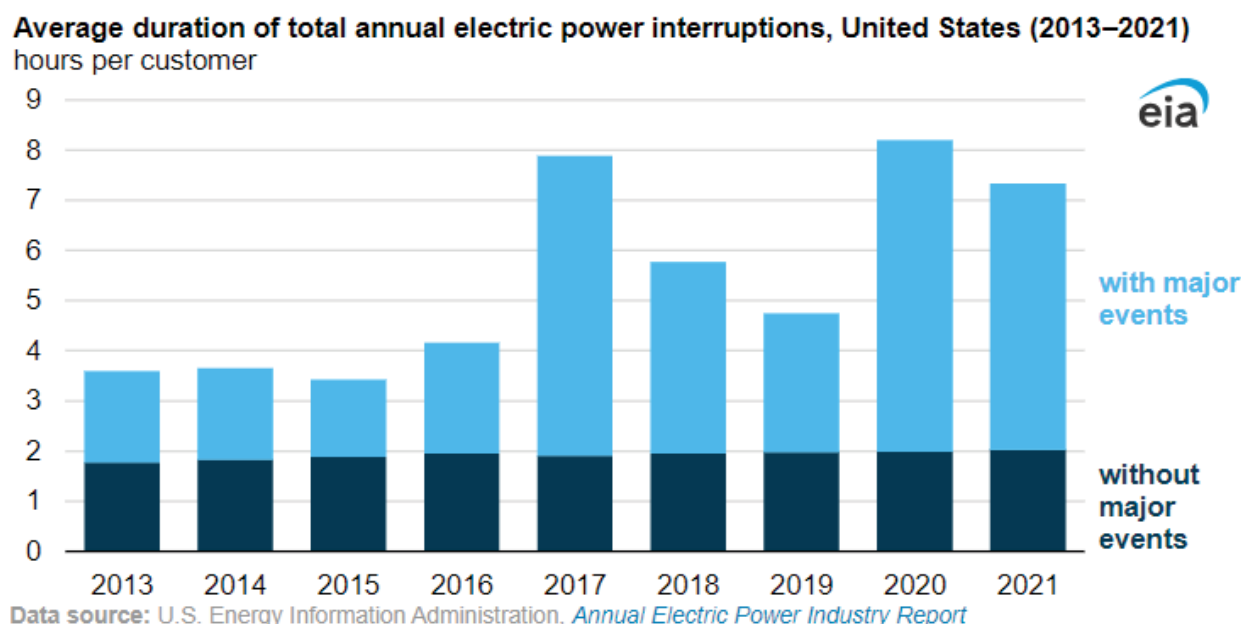

Figure 1. Three recent years – 2017, 2020, and 2021 – have seen record grid outages, negatively impacting U.S. consumers and businesses.

When major events are excluded, the average duration of power interruptions customers experienced each year from 2013 to 2021 was around two hours. Different factors cause these interruptions, including bad weather, overgrown vegetation, and lagging utility practices, such as insufficient maintenance of legacy systems and components. Utilities report interruption duration values with significant events (including snowstorms, wildfires, and hurricanes), without significant events, or both.

Data centers obviously can't go without power, even for a few minutes. As a result, operators' preferred option for gaining extended backup power is the diesel genset. However, since diesel gensets go primarily unused, this source of stranded power isn't an ideal allocation of companies' financial or energy resources. Battery energy storage systems (BESS), an always-on energy source, can contribute to day-to-day supply, improve operational resiliency, and deliver sustainability benefits. As a result, they are far more appealing to a range of buyers, including enterprise and multi-tenant data center owners.

When used with a microgrid, a BESS can be connected to various distributed power generators to create a hybrid solution, providing local users with multiple power and energy sources they can flexibly tap into, to achieve their goals. This new system can be leveraged to reduce emissions by strategically switching to low- or no-carbon energy sources and allow operators to generate revenue streams by participating in reserve markets. As a result, these distributed systems are less expensive to operate than diesel gensets. By developing a microgrid system with one or more BESSs, businesses can manage their always-on energy assets in an intelligent, transparent way that idle generators can't match.

Before exploring the business value that BESS systems and microgrids can create for enterprises and multi-tenant data centers (MTDCs), let's take a moment to review and align on common terminology.

## What Is a Microgrid?

A microgrid is a self-sufficient energy system that serves a discrete geographic footprint, such as a mission-critical site or building. A microgrid typically uses one or more kinds of distributed energy that produce power. In addition, many newer microgrids contain battery energy storage systems (BESSs), which, when paired with advanced power electronics, can mimic the output of a generator without its long startup time. Connected to a nearby building or campus, this hybrid distributed energy solution (DES) delivers power via a distribution grid to local users, with a digital control system matching supply and demand.

## Microgrid Characteristics

**A microgrid is local:** Like digital gensets, microgrids provide local access to power and can serve as a backup energy source if the grid goes down. However, unlike diesel gensets, microgrids provide always-on energy sources that are more efficient and can provide societal, sustainability, and economic benefits.

Central grids push electricity from power plants over long distances via transmission and distribution lines. Delivering power from afar is inefficient because as much as 5% of the electricity dissipates in transit. A microgrid prevents these losses by generating power close to those it serves: The generators are near or within the building, or in the case of solar panels, on the roof.

**A microgrid is independent:** In addition, a microgrid can disconnect from the central grid and operate independently. This islanding capability allows microgrids to supply power to their customers when a storm or other event causes a power grid outage. Local generation and the ability to island with microgrids yields higher uptime for end users and benefits the central grid. During times of stress, disconnecting large loads helps the bigger grid maintain balance for those smaller customers who also need power.

While microgrids can run independently, most of the time, they do not. Instead, microgrids typically remain connected to the central grid. As a result, they can provide grid services that help bolster grid power quality and maintain stability.

**A microgrid can include resources:** Microgrids may contain DERs connected via switchgear and controlled by an intelligent microgrid controller. These energy resources may include assets such as BESSs, solar panels, thermal energy storage, combined heat and power, wind power, fuel cells and reciprocating engine generators, linear generators, turbines, and more. Installing a variety of DERs enable users to pick and choose among fuel sources to achieve goals such as improving sustainability, performance, peak or average load, market participation, and more.

Microgrids have onsite control systems: Adding DER assets to a local grid comes with challenges, so operators rely on a decentralized digital control system to automate processes. Linking supply and demand in a high-speed dance provides necessary coordination in generation, power distribution, and consumption. The microgrid controller is a digital system that manages the DERs, the switching logic, and nearby building energy demand with a high degree of sophistication. The system is adjusted based on available resources if the microgrid owner wants to achieve low cost or high uptime.

## What a Microgrid is Not

It's important to note what a microgrid is not. Some use the term to describe a simple DES, such as rooftop solar panels. However, a microgrid will keep power flowing when the central grid fails; a solar panel alone will not. Many building operators with solar panels are unaware of this fact and are surprised that they lose power during a grid outage.

Simple backup generators also are not microgrids. Such systems are only employed in emergencies, while microgrids operate 24/7/365, managing and supplying energy to their customers.

## Microgrid Control Systems

Microgrids provide vital controls that help users ensure power continuity, reduce power usage costs, and contribute to grid services. These systems:

**Improve functional resiliency:** One of a microgrid's most important distinctions is its functional resiliency, which it creates by enabling fail-safe islanding of a mission-critical emergency power branch circuit and reliable power backup services during grid outages.

A microgrid provides a seamless energy transition from external power to the main grid. Such a transition can be planned or unplanned, the latter being most difficult as Loss of Utility (LoU) or Recovery of Utility (RoU) power are unanticipated. Next to LoU and RoU, the utility may also send a Demand to Disconnect (DtD) in anticipation of LoU due to utility power interruptions (such as rolling brownouts, wildfire conditions, and other serious issues). In addition, the microgrid may issue a Request to Reconnect (RtR) in the case of RoU, where reconnection typically requires the microgrid to follow regulations to avoid accidental powering of utility assets.

It is worth noting that a resilient microgrid requires a synchronized disconnect and startup of a short-term critical load support when a LoU occurs to provide so-called "flicker-free" critical load demand. In a fully seamless microgrid, such short-term critical load support should also be available in case of a DtD to enable the microgrid to anticipate a planned or unplanned utility outage. Since the microgrid is always-on, it can provide critical load support, increasing operational resiliency.

**Provide always-on backup power:** The microgrid also provides additional services when it is connected to the grid, enabling users to reduce electricity costs due to time of use energy cost, peak demand tariffs, and grid services.

As previously discussed, time of use (ToU) refers to the price of electric energy (typically measured in kWh) as a function of the time of day in a week; it is also seasonally adjusted. Peak demand is the measured maximum power peak during a monthly billing cycle. Reducing both can lead to a significant reduction of electricity costs. For industrial facilities, peak demand tariffs may be up to 30% to 70% of the monthly electricity bill.

An always-on DER in the microgrid can produce energy when the when pricing is high. Figure 2 below illustrates the comparison between controlled and uncontrolled power, showing a significant reduction in power and energy demand between 12:00 noon and 7:00 PM. Electrical engineers can achieve such a reduction by planning the next day's photovoltaic (PV) output combined with energy storage (battery) capacity to provide power after the sun has set and PV power production has been diminished.

In addition, by measuring the real-time power flow over the Point of Common Coupling (PCC) to the utility, teams can reduce additional power peaks to limit peak demand charge tariffs. It can be challenging for electrical engineers to reduce power peaks with day-ahead planning as they can be unpredictable. In such cases, real-time power measurements provided by a microgrid controller can help teams coordinate DERs and reduce peak demand.

**Offer switch logic, power control, and planning capabilities:**

The microgrid controller is the central processing unit that coordinates energy resources and loads, ensuring seamless energy transfers. Illustrations often depict these controllers as centralized. However, a best practice is to organize them in a distributed fashion throughout the microgrid because supply and demand are extremely sensitive to latency issues.

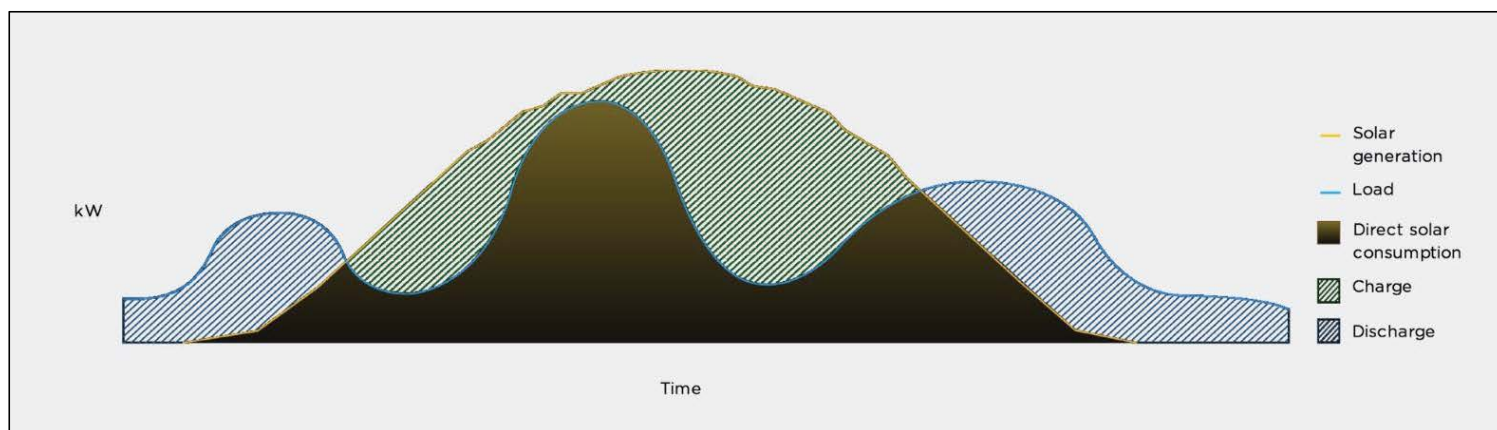

Figure 2. How data center teams can use DERs in microgrids to reduce power and energy demand during peak demand tariffs.

Microgrid controllers should provide the ability to:

- Integrate existing and new energy resources as the microgrid expands over time.
- Provide services to manage utility costs (ToU and peak demand tariffs).
- Be reconfigured for contingency events and guarantee continuity of critical loads.
- Enable seamless islanding in case of LoU or on-demand.
- Adapt planning for daily energy demand (such as ToU costs) when energy storage capability requirements change over time.
- Operate autonomously but allow intervention by qualified personnel.
- Provide system status and history for each DER and planning process.
- Be configurable to protect the security of the microgrid.

## Maximizing Grid Services

With microgrid controllers and always-on DERs, businesses can participate in the reserve markets and gain financial rewards. Grid services include:

- 1. Voltage and Frequency Services.** Microgrid owners can use DERs to opt into their utility's paid service when connected to the grid. The utility grid operator will provide a direct command control sequence to the microgrid controller, which commands the system to assist the utility in maintaining local grid power quality. The controller then issues commands to one or all the DERs to respond to the utility's requirement.
- 2. Utility Demand Management.** Microgrid owners may be able to leverage battery storage devices and their knowledge of the local utility's rate structure to avoid demand charges. They can monitor and predict the utility's load and respond to daytime power consumption peaks by activating battery output to reduce utility costs due to demand charges.
- 3. Time of Use Load Management.** Although the microgrid controller is expected to manage the load during an islanding event, it can also do so during grid-connected mode. The controller can recommend and activate loads at various times of day when utility rates are favorable but don't overly impact client operations. During the utility-connected mode of operation, a microgrid owner can use the always-on DERs in the grid to opt into paid service by the utility companies. When the utility grid operator issues a direct command control sequence to one or all DERs to maintain, this microgrid controller feature commands the system to assist the utility. The grid and microgrid services work together to improve local grid power quality.

## Power Control and Planning Capabilities

| Functionality      | Time Scale             | Purpose  |
|--------------------|------------------------|--|
| Switch Logic       | < 20m sec              | Synchronized disconnect and startup/switcing of inverter                               |
| Power Flow Control | 2ms                    | Synchronized disconnect and startup/switcing of inverter                               |
| Energy Planning    | 5min - 15min intervals | Keeping energy storage within constraints, planning for Time of Use (ToU) optimization |

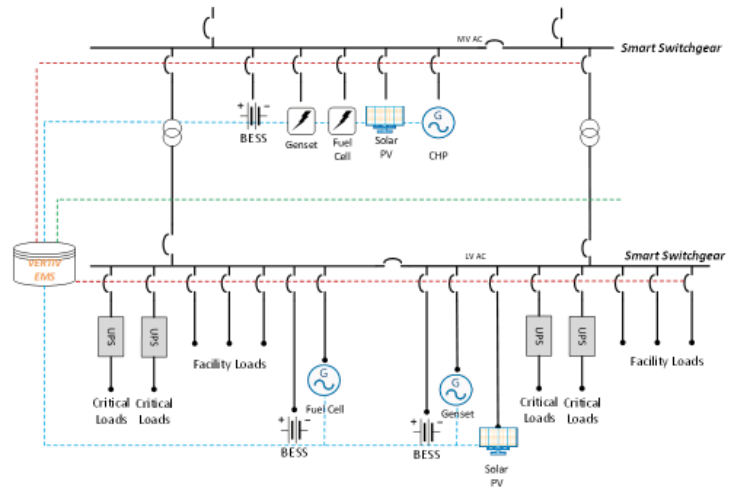

Figure 3. Using microgrid controllers to plan DER power use.

## Implementing Switchgear

Switchgear enables microgrids to physically connect and disconnect from the grid and operate in an islanding mode for extended periods. Switchgear also de-energizes equipment to allow teams to conduct critical maintenance work and clear faults downstream. Products that make up the switchgear category include breakers, high-voltage outdoor power circuit breakers and switches, low- and medium-voltage power circuit breakers, pad-mounted switching equipment, power switchgear assemblies, reclosers, and sectionalizers.

A switchgear assembly typically has two types of components:

- Power-conducting components such as switches, circuit breakers, fuses, and lightning arrestors that conduct or interrupt the flow of electrical power.
- Control systems, such as control panels, current transformers, potential transformers, protective relays, and associated circuitry that monitor, control, and protect the power-conducting components.
- Switchgear is located on the high- and low-voltage sides of large power transformers in substations. On the low-voltage side, switchgear can be used with medium-voltage (MV) circuit breakers for distribution circuits, metering (MV) control, and protection equipment.

## Why is the Modern BESS Using Li-Ion Batteries?

BESSs using long-life, heat-tolerant lithium ferrophosphate (LFP) batteries are well-suited for commercial campus settings, like mission-critical microgrids. In addition, the declining cost of lithium-ion batteries and their improved energy density have made them the primary choice for these applications.

Typically, a BESS is comprised of battery cells arranged into modules and connected into larger cubes to achieve the desired direct-current (DC) voltage. The collected DC outputs from those strings are routed into a four-quadrant inverter called a power conversion system (PCS). The PCS converts the power to alternating current (AC) and then routes it through transformers and switchgear where the facility or the grid can use it. (See Figure 4 below.)

## Physical Energy Storage System

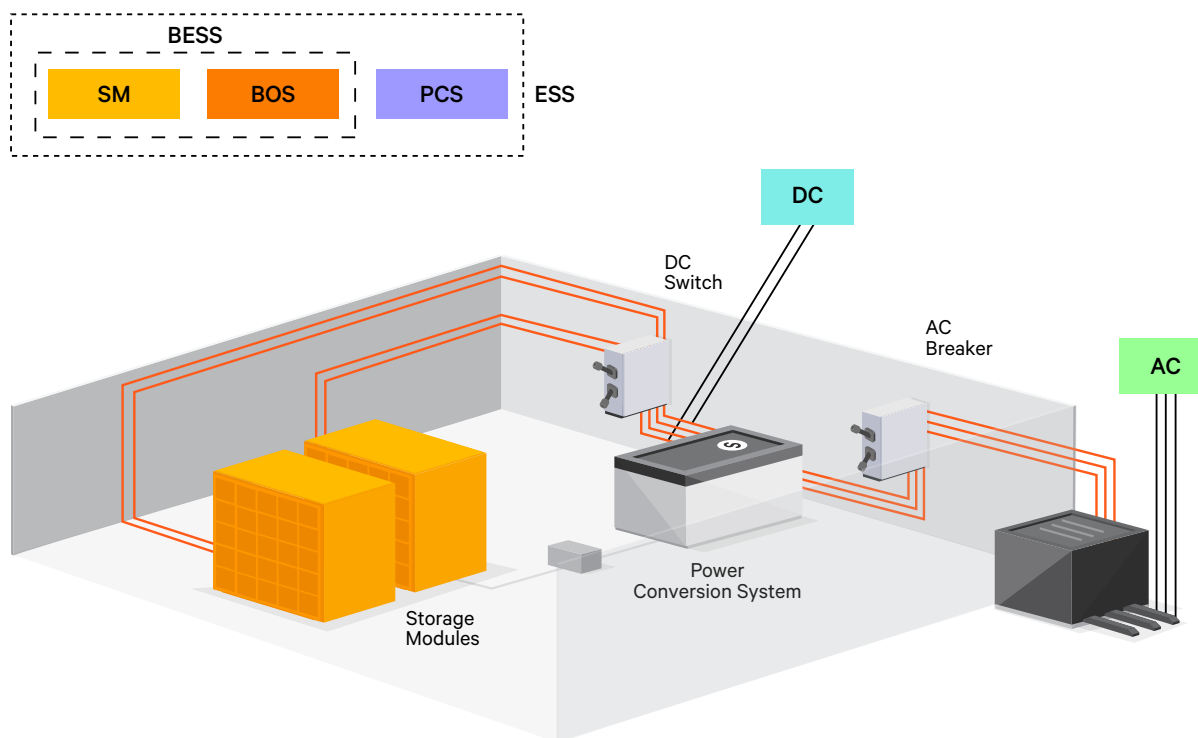

Figure 4: BESS Primary Elements (Lazard 2017).

## Selected Equipment & Cost Components

| System Layer |   | Component  |   |
|--------------|---|--|---|
| SM           | Storage Module                          | <ul style="list-style-type: none"> <li>Racking Frame/Cabinet</li> <li>Battery Management System ("BMS")</li> </ul> | <ul style="list-style-type: none"> <li>Battery Modules</li> </ul>   |
| BOS          | Balance of System                       | <ul style="list-style-type: none"> <li>Container</li> <li>Monitors and Controls</li> </ul>                         | <ul style="list-style-type: none"> <li>Thermal Management</li> <li>Fire Suppression</li> </ul>                                      |
| PCS          | Power Conversion System                 | <ul style="list-style-type: none"> <li>Inverter</li> <li>Protection (Switches, Breakers, etc.)</li> </ul>          | <ul style="list-style-type: none"> <li>Energy Management System ("EMS")</li> </ul>  |
| EPC          | Engineering, Procurement & Construction | <ul style="list-style-type: none"> <li>Project Management</li> <li>Engineering Studies/Permitting</li> </ul>       | <ul style="list-style-type: none"> <li>Site Preparation/Construction</li> <li>Foundation/Mounting</li> <li>Commissioning</li> </ul> |
|              | Other (not included in analysis)        | <ul style="list-style-type: none"> <li>SCADA</li> <li>Shipping</li> </ul>  | <ul style="list-style-type: none"> <li>Grid Integration Equipment</li> <li>Metering</li> <li>Land</li> </ul>                        |



## How a BESS Powered Microgrid Benefits the Campus

Incorporating a BESS into a microgrid can provide benefits that can be combined to create “value-stacking.” This is possible when a site can leverage two or more use cases using the microgrid controller.

**Application #1: Peak Demand Reduction.** Many utilities have demand reduction programs incentivizing facilities to reduce electricity consumption during peak periods. In critical power facility settings, participating in these types of programs is only practical and possible if power can be supplemented from another source. Peak demand periods typically last about four hours, which is well-suited to the capacity offered by a BESS. A BESS can be charged slowly during low demand and low time-of-use (TOU) rates and then discharged during peak demand periods to provide all facility power, avoiding the use of grid power. (See Figure 5 below.) When combined with a microgrid, peak demand reduction can be accomplished without using microgrid assets that burn fossil fuels, such as diesel or natural gas generators.

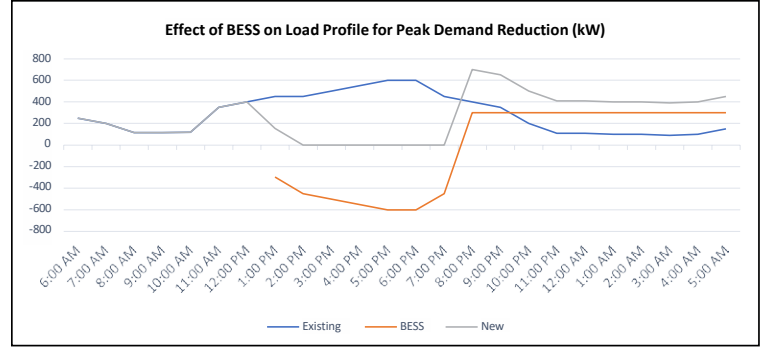

Figure 5. BESS Used to Avert a Peak Demand Event

**Application #2: Renewable Energy Firming.** One of the better-understood applications of a BESS with a microgrid controller involves using a solar photovoltaic (PV) installation to smooth out intermittent fluctuations of solar production. (See Figure 6.) This application can prevent the need for utilities to curtail solar production while enabling the harvesting of solar generation that might be wasted during ramp-up and ramp-down caused by production fluctuations (such as what is experienced during cloud cover).

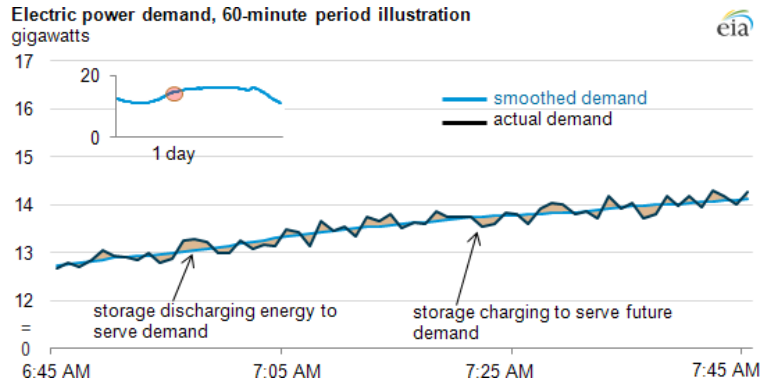

Figure 6. ESS Used for Renewable Firming (U.S. Energy Information Administration 2012)

**Application #3: Spinning Reserve.** Many microgrids use multiple generators to serve the load. Because a microgrid’s load will fluctuate, generators typically are sized in increments to serve “stages” of load need. If the overall load is low, the first stage of generator capacity kicks in. When additional power is needed, the second stage of generator capacity will fire up. The problem with this strategy is that gas generators have a preferred efficiency window to optimize efficiency and fuel consumption. This “sweet spot” is usually around 30% to 40%, so if a second (or third) generator is cycling on and off, it reduces efficiency, consumes more fuel, produces more emissions, and creates wear and tear on the device. Combining a BESS with a generator ensures it can serve an additional marginal load before activating another generator. This can help keep generators within their optimal efficiency windows. (See Figure 7.)

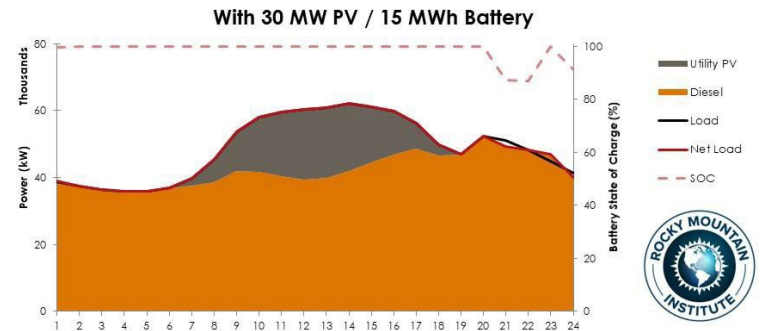

Figure 7. BESS Used for Spinning Reserve (RMI 2017)



## How to Plan BESS Integrations into Microgrids

Planning for BESS integration into a microgrid involves many of the same considerations as integrating other power generation, transmission, and distribution assets, such as generators and substations, along with a few specific to microgrid controllers and batteries.

**Consideration #1: Duration Limitations.** The first myth that needs to be dispelled when incorporating a lithium-ion battery (LIB)-based BESS into a microgrid is the notion that the BESS can replace a backup generator. A LIB-based BESS has a discharge duration of around four hours. Backup power duration requirements in many locations around the globe may be up to 72 to 96 hours. Therefore, a BESS should either be used as a short-term backup supply for the entire facility or a longer-term backup supply for priority facility loads.

A second myth is that solar power plus battery storage can provide an adequate backup power source for a facility. Given the land use requirements of solar and battery storage, as depicted in Figure 8, integrating a completely self-reliant solar-with-storage solution for the entire backup power duration becomes prohibitive.

**Consideration #2: Capital Cost Barriers.** Although energy storage costs have dropped drastically in the last ten years, implementing a complete BESS still faces commercial challenges unless owners realize multiple revenue streams from this investment, such as managing energy demand onsite and participating in reserve markets. This business case will improve in the coming years as costs decline and BESS-centric regulations evolve. However, owners making investments now need to answer questions such as:

- What is the magnitude of the annual demand charges?
- Are there frequent short-term outages that impact mission-critical operations that the BESS could mitigate?
- What is the power factor at the site?
- Does the utility charge fees based on the site power factor?
- How many incoming utility feeders serving the site would potentially need to integrate with the BESS?
- What operational/maintenance and fuel costs are associated with the current backup generator fleet, if any? How often do generators operate outside their peak efficiency windows?

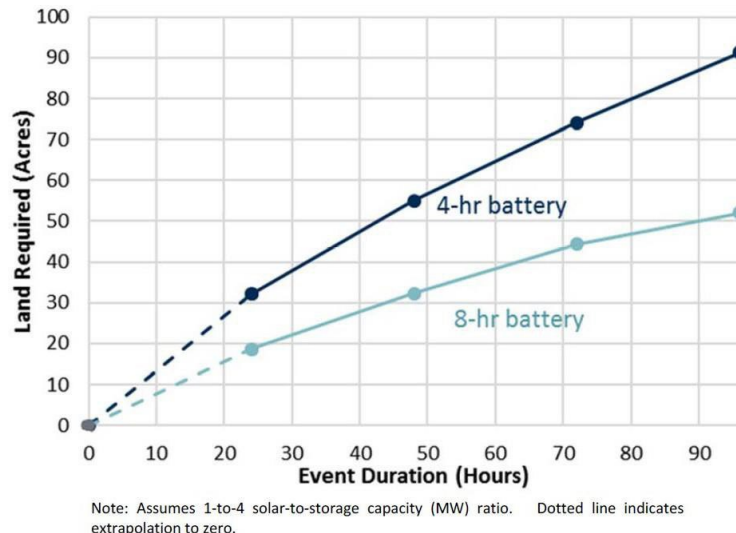

Figure 7. Solar + Storage Land Requirement as Function of Event Duration (Hledik et al. 2020)

**Consideration #3: Fire Safety of a BESS.** Fire safety of a stationary BESS is a significant consideration for urban installations. There have been recent fire incidents in Arizona and frequent battery fires in South Korea in 2019. LIBs exhibit several characteristics that can cause both explosive gases (off-gassing) before a thermal event and thermal runaway events when a battery cell separator is bridged. (See Figure 9 below.) LIB fires cannot be easily extinguished with conventional fire suppression methods. As a result, sites using LIBs should ensure they meet the new NFPA 855-20, Standard for the Installation of Stationary Energy Storage Systems to ensure fire safety.

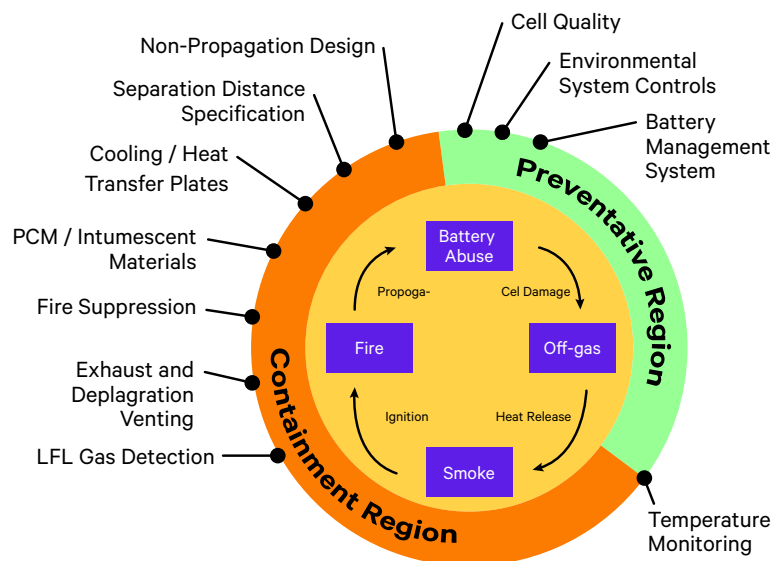

Figure 9. LIB Thermal Event Cycle (American Fire Technologies 2018)

In conjunction with NFPA 855, prospective BESS owners should consider the following items:

- Does the BESS supplier adhere to the requirements of NFPA 855?
- Is the complete battery system certified to meet UL9540A, which ensures fire is contained within a single rack if a thermal event occurs?
- What will be used for fire suppression? Traditional clean agents and aerosols are ineffective for containing LIB thermal events since the explosive off-gasses from the batteries must be exhausted, which would also exhaust these clean agents. Water deluge is the best method to cool these batteries.
- Will the BESS manufacturer provide an electrolyte gas detection system to detect off-gassing before a thermal event starts?
- If water is used to cool a thermal event, how will the spent water be disposed of? (A floor drain may not be suitable).

## A Final Thought on Connecting to Utilities

Integrating a BESS into a microgrid is often like interconnecting other DERs, such as generators and PV solar farms. The PCS used for the BESS must comply with the same standards as solar PV inverters (such as IEEE 1547-2018). Yet, what if an owner never intends to export power to the grid but simply wants to use the BESS to support facility loads? The BESS is merely a load and should not be treated as a generator. The protection and control system can be configured to trip the BESS if it ever tries to send power back to the grid. (This is called a “32 reverse power flow element”). However, the concern that the utility has is possible reactive and/or short-circuit power contributions the BESS could still have on the grid.

## Conclusion

Mission-critical facilities and other organizations need reliable electric power. Long-term power outages that last for days tax existing on-site emergency generators, typically running a maximum of four hours every three years during a compliance test. A microgrid provides the reliability required to meet the needs of critical power facilities, and as the market matures, we find these projects are becoming more financially viable. Simply put, the microgrid may be organizations’ best alternative for increasing operational reliability by adding resiliency via hybrid power and offsetting energy costs by participating in grid services, and pursuing sustainability goals.

There are several options for local power generation in a microgrid, and the choice depends on application and other factors. A BESS offers the best combination of reliability, functionality, and economic flexibility in many scenarios.

<sup>1</sup> Annual Electric Power Industry Report, 2021, Form EIA-861, U.S. Energy Information Administration (EIA), page 186, <https://www.eia.gov/electricity/annual/pdf/epa.pdf>.

<sup>2</sup> Rosalyn Barry, “U.S. Electricity Customers Averaged Seven Hours off Power Interruptions in 2021,” article, EIA, November 14, 2022, <https://www.eia.gov/todayinenergy/detail.php?id=54639#>.

<sup>3</sup> Also known as distributed energy resources (DERs).

<sup>4</sup> Average annual electrical loss over transmission and distribution lines in the U.S. from 2017 to 2021, as shared in “Frequently Asked Questions (FAQs),” EIA, last updated November 14, 2022, <https://www.eia.gov/tools/faqs/faq.php?id=105&t=3>.

<sup>5</sup> Demand Response in Industrial Facilities: Peak Electric Demand, ORNL/SPR-2021/2299, US Department of Energy, page 6, [https://betterbuildingsolutioncenter.energy.gov/sites/default/files/attachments/Demand%20Response%20in%20Industrial%20Facilities\\_Final.pdf](https://betterbuildingsolutioncenter.energy.gov/sites/default/files/attachments/Demand%20Response%20in%20Industrial%20Facilities_Final.pdf).

<sup>6</sup> “Arizona battery fire’s lessons can be learned by industry to prevent further incidents, DNV GL says,” article, Energy Storage News, July 29, 2020, <https://www.energy-storage.news/arizona-battery-fires-lessons-can-be-learned-by-industry-to-prevent-further-incident-dnv-gl-says/>.

## References

- American Fire Technologies (2018). Li-Ion Tamer Partners with American Fire Technologies. The Journal of Biological Chemistry. Retrieved from <https://www.aft.net/news/li-ion-tamer-partners-with-american-fire-technologies-for-increasing-safety-of-li-ion-energy-storage-systems/>
- Annual Electric Power Industry Report, 2021, Form EIA-861, U.S. Energy Information Administration (EIA), <https://www.eia.gov/electricity/annual/pdf/epa.pdf>
- Asmus, Peter, Adam Forni, and Laura Vogel. Navigant Consulting, Inc. 2017. Microgrid Analysis and Case Study Report. California Energy Commission. Publication Number: CEC-500-2018-022.
- Baruch, S.J. National Director Energy and Utilities, National Facilities Services, Kaiser Permanente (2020, November)
- Emergency Generator 4-hour Load Test. (2020). Retrieved from <https://www.jointcommission.org/standards/standard-faqs/home-care/environment-of-care-ec/000001267/>
- Goldie-Scot, Logan. (2019). A Behind the Scenes Take on Lithium-Ion Battery Prices. BloombergNEF. Retrieved from <https://about.bnef.com/blog/behind-scenes-take-lithium-ion-battery-prices/>
- Hledik, Ryan, Peter Fox-Penner, Roger Lueken, Tony Lee, and Jesse Cohen. 2020. Decarbonized Resilience: Assessing Alternatives to Diesel Backup Power. IEA. (2020). World Energy Outlook 2020.
- Konakalla, S.A.R, Valibeygi, A. and de Callafon, R.A. (2020). Microgrid Dynamic Modeling and Islanding Control with Synchronphasor Data. IEEE Transactions on Smart Grid 11 (1), pp. 905-915, doi: 10.1109/TSG.2019.2948815.
- Lasseter, R. H., & Paigi, P. (2004, June). Microgrid: A conceptual solution. In 2004 IEEE 35th Annual Power Electronics Specialists Conference (IEEE Cat. No. 04CH37551) (Vol. 6, pp. 4285-4290). IEEE.
- Lazard. (2017). Lazard's Levelized Cost of Storage Analysis –Version 3.0 Lazard. (2019). Lazard's Levelized Cost of Storage Analysis - Version 5.0.
- Marqusee, J., Ericson, S., & Jenket, D. (2020). Emergency Diesel Generator Reliability and Installation Energy Security (pp. iv-36, Tech. No. NREL/TP-5C00- 76553). Golden, CO: National Renewable Energy Laboratory. Doi: <https://www.nrel.gov/docs/fy20osti/76553.pdf>
- Mey, A. (2020). U.S. Energy Information Administration - EIA - Independent Statistics and Analysis.
- Retrieved from <https://www.eia.gov/todayinenergy/detail.php?id=45136>
- National Fire Protection Association. (1989). National fire codes: A compilation of NFPA codes, standards, recommended practices, manuals and guides. Quincy, Mass: National Fire Protection Association.
- Prabakar, K., Valibeygi, A., Konakalla, S., Miller, B., de Callafon, R.A., Pratt, A., Symko-Davies, M., Bialek, T. (2020), Remote Hardware-in-the-Loop Approach for Microgrid Controller Evaluation. NREL Technical Report, NREL/CP-5D00-74887.
- U.S. Energy Information Administration (2012). Electricity Storage Can Smooth out Moment-to-Moment Variations in Electricity Demand. The Journal of Biological Chemistry. Retrieved October 30, 2020 (<https://www.eia.gov/todayinenergy/detail.php?id=6370>).
- van Zalk, John, and Paul Behrens (2018). The Spatial Extent of Renewable and Non-Renewable Power Generation: A Review and Meta-Analysis of Power Densities and Their Application in the U.S. Energy Policy 123:83–91. doi: 10.1016/j.enpol.2018.08.023.
- Valibeygi, A., de Callafon, R.A. Stanovich, M., Sloderbeck M. and Meeker, R. (2018). Microgrid Control Using Remote Controller Hardware-in-the-Loop Over the Internet. 2018 IEEE Power and Energy Society Innovative Smart Grid Technologies Conference (ISGT), Washington, DC, pp. 1-5, doi: 10.1109/ISGT.2018.8403345.
- Valibeygi, A. and de Callafon, R.A. (2019) Cooperative Energy Scheduling for Microgrids under Peak Demand Energy Plans, 2019 IEEE 58th Conference on Decision and Control (CDC), Nice, France, 2019, pp. 3110-3115, doi: 10.1109/CDC40024.2019.9028866
- Valibeygi, A., Konakalla, S.A.R., de Callafon, R.A. (2020). Predictive Hierarchical Control of Power Flow in Large-Scale PV Microgrids with Energy Storage, IEEE Transactions on Sustainable Energy, doi: 10.1109/TSTE.2020.3001260.



**Vertiv.com** | Vertiv Headquarters, 505 N Cleveland Ave, Westerville, OH 43082, USA

© 2024 Vertiv Group Corp. All rights reserved. Vertiv™ and the Vertiv logo are trademarks or registered trademarks of Vertiv Group Corp. All other names and logos referred to are trade names, trademarks or registered trademarks of their respective owners. While every precaution has been taken to ensure accuracy and completeness here, Vertiv Group Corp. assumes no responsibility, and disclaims all liability, for damages resulting from use of this information or for any errors or omissions. Specifications, rebates and other promotional offers are subject to change at Vertiv's sole discretion upon notice.